



# CROSSLINE LASER LEVEL WITH PLUMB DOTS

MODEL NO.: DT1H1V2PR DT1H1V2PG



**TO PREVENT SERIOUS INJURY, READ  
AND UNDERSTAND ALL WARNINGS  
AND INSTRUCTIONS BEFORE USE**

**OPERATING  
INSTRUCTIONS**

# TABLE OF CONTENT

SPECIFICATIONS .....3  
HAZARD SIGNAL WORD DEFINITIONS .....3  
GENERAL SAFETY RULES FOR OPERATION .....4  
COMPONENT IDENTIFICATION.....5  
OPERATION INSTRUCTION .....6  
CALIBRATION CHECK.....7  
MAINTENANCE AND SERVICE.....9  
TROUBLESHOOTING .....9  
PRODUCT LABELS .....10  
WARRANTY INFORMATION .....12

# ABOUT YOUR LASER LEVEL





Thank you for purchasing this DATUM CROSSLINE LASER LEVEL. Your laser level features extra bright laser technology, horizontal/vertical crossline operations and a pendulum lock. It's ideal for carpentry, interior layout, tiling, plumbing and electrical layout from floor to ceiling.

Please read and understand the content of this instruction manual before using this product. Save this manual for future reference.

| SPECIFICATIONS                  |   |                       |
|---------------------------------|---|-----------------------|
| MODEL                           | DT1H1V2PR                                   | DT1H1V2PG             |
| BEAM COLOUR                     | RED   | GREEN                 |
| LASER CLASS                     | Class II                                    | Class II              |
| LASER WAVELENGTH                | 635nm                                       | 515nm                 |
| ACCURACY                        | ±2 mm at 10m                                | ±2 mm at 10m          |
| OPERATING RANGE (INDOOR)        | 15m   | 15m                   |
| OPERATING RANGE (WITH DETECTOR) | 50m   | 50m                   |
| AUTO LEVELLING RANGE            | ±4°   | ±4°                   |
| BATTERY LIFE (CONTI. OPERATION) | 10 Hours                                    | 7 Hours               |
| POWER SUPPLY                    | 4 x AA 1.5V batteries                       | 4 x AA 1.5V batteries |
| LINE PATTERN                    | 1H1V  | 1H1V                  |
| PLUMB DOTS                      | Up and Down                                 | Up and Down           |
| IP RATING                       | IP54  | IP54                  |
| TRIPOD THREADS                  | 1/4"  | 1/4"                  |
| DETECTOR                        | Optional (Part No. DT01REC sold seperately) |                       |

DATUM is constantly improving its products. All information in this manual is based on the latest product information available at the time of printing. The specifications outlined herein are subject to change without prior notice or obligation. The purchaser and/or user shall assume liability for any modification and/or alterations of this equipment from original design and manufacture.

## HAZARD SIGNAL WORD DEFINITIONS

|  |  |
|--|--|
|                 | Indicates an imminently hazardous situation which, if not avoided, will result in death or serious injury. Obey all safety messages that follow this symbol to avoid possible injury or death. |
|  <b>DANGER</b>  | Indicates an imminently hazardous situation which, if not avoided, will result in death or serious injury.   |
|  <b>WARNING</b> | Indicates a potentially hazardous situation which, if not avoided, could result in death or serious injury.  |
|  <b>CAUTION</b> | Indicates a potentially hazardous situation which, if not avoided, may result in minor or moderate injury.   |
| <b>CAUTION</b>   | Used without the safety alert symbol indicates a potentially hazardous situation which, if not avoided, may result in property damage.   |

# GENERAL SAFETY RULES FOR OPERATION



## WARNING

Read all safety warnings, instructions, illustrations and specifications provided with this laser level. Failure to follow all instructions listed below may result in personal injury.

### Save all warnings and instructions for future reference.

- Do not stare into beam regardless of distance.
- Do not use the laser intensive glasses as safety goggles, sunglasses or when driving.
- Do not point laser in the direction of other people or animals.
- Do not point laser in the direction of mirrors or other reflective surfaces.
- Store in a secure location when not in use.
- This is a quality laser measuring device and is 100% factory adjusted within the stated tolerance.
- Laser should not be used as a toy or by children.
- Do not view beam through optical instruments such as theodolites, binoculars, cameras or magnifying lenses.
- Avoid using laser in darkened areas. Ensure sufficient light levels to avoid damage to eyes.
- Set up cross line laser to ensure laser beam path is above or below eye level.
- Ensure cross line laser is securely set up to avoid accidental movement.
- Always ensure the laser beam is aimed at a sturdy work piece without reflective surface. Bright shiny reflective sheet steel or the like is not suitable for laser use as the reflective surface could direct the beam back at the operator.
- Do not break up or throw the battery into fire, please recycle the battery after use.
- Turn the laser off when it is not in use. Leaving the laser on increases the risk of staring into the laser beam.
- Do not use or store the instrument in locations where the temperature may reach or exceed 40°C.
- Do not disassemble the instrument or attempt to perform any internal servicing as this will void your warranty. Not user serviceable parts included. Only approved and authorised service technicians can carry out warranty repairs.
- Avoid direct eye exposure. Consult your laser safety officer or IEC 60825.14:2011 Part 14 for best operating practice.



## CAUTION

Class 2 laser product according to IEC 60825-1:2014.  
Do not stare into the laser beam or direct it towards other people.

# COMPONENT IDENTIFICATION



1. Power switch / pendulum lock
2. Control panel
3. Vertical laser output window
4. Up plumb dot output window
5. Horizontal laser output window
6. 1/4" Tripod thread
7. Down plumb dot output window
8. Battery compartment
9. Wall bracket
10. Magnets on b
11. Height adjustment knob
12. 1/4" thread
13. Down plumb dot window
14. 5/8" Tripod thread
15. 1/4" Tripod thread

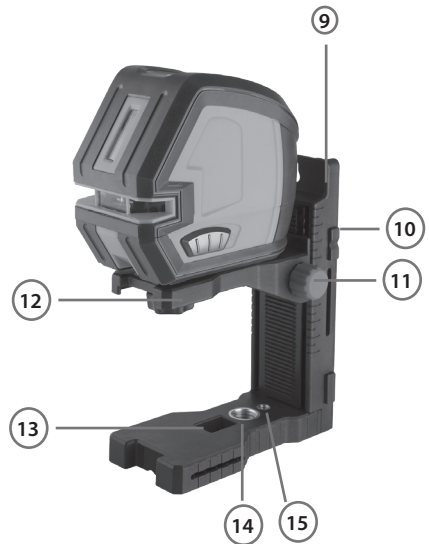

# OPERATION INSTRUCTION

## BATTERY PLACEMENT

- Your laser level requires 4 AA batteries. Use only new, high-quality battery for best results.
- Locate battery compartment at the bottom of the laser. Insert batteries according to the symbols and polarity.
- When the battery voltage is low, the indicator light will start flashing in which the batteries must be replaced.
- Once the voltage is below 3.9V, the unit will shut off automatically due to low battery.

## ON/OFF

|   |   |
|---|---|
|  <b>WARNING</b> | Always turn off all lasers and latch the pendulum in place before transporting. |
|---|---|

- Press and hold "LINE" button to switch on the laser.
- Alternatively, turn the laser on by sliding the Power Switch/Pendulum Switch to ON/ UNLOCK position. Pendulum is automatically released for self levelling.
- To turn the laser off, place it on a stable flat surface. Slide the Power Switch/Pendulum Switch to OFF/LOCK position. Pendulum is automatically locked when the switch is turned to OFF position.

## LASER LINES SELECTION

- Turn the switch to ON position. All lines appear when the laser is turned on.
- Press "LINE" button to select laser lines.

## AUTOMATIC SELF-LEVELLING

- Pendulum lock (power switch to ON position) must be released for horizontal and vertical levelling.
- Turn on the laser level. The pendulum automatically aligns a position within the range of self-levelling range  $\pm 4^\circ$ . Within this range, the laser level automatically correct its position.
- Laser beams start to blink when the device is out of self-alignment range of  $\pm 4^\circ$ . In this case, place the laser level on a flat surface, adjust tripod or wall mount until blinking stops.

## PULSE MODE

- Press  to activate Pulse Mode so that the device can work with optional laser detector.
- Laser lights will pulse with high frequency, making the laser lines slightly darker.
- Pulse Mode LED Indicator light will be on when this is activated. Press the button again to exit pulse mode.

|   |   |
|---|---|
|  <b>WARNING</b> | This is a high precision instrument - To avoid damage always transport instrument and store with pendulum lock on (or power switch to OFF position) and in its protective case. |
|---|---|

# CALIBRATION CHECK

It's possible for you to check the calibration of the laser. Calibration by yourself is only approximate and the accuracy of the calibration will depend on the care with which you proceed.

## TO CHECK THE LEVEL

Checking the horizontal pitch calibration of the laser requires 2 walls, which must be at least 5 metres apart. The best calibration results can be achieved if the laser is mounted on a tripod.

1. Mark point A1 on the wall.
2. Turn the device 180° and mark A2 on the opposite side of A1. You now have a horizontal reference between point A1 and A2.

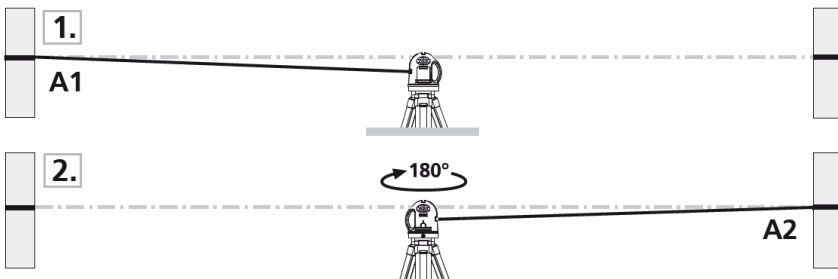

3. Position the device as near as possible to the wall at the same height of point A1.
4. Turn the device 180° and mark point A3. The difference between point A2 and A3 is the tolerance.

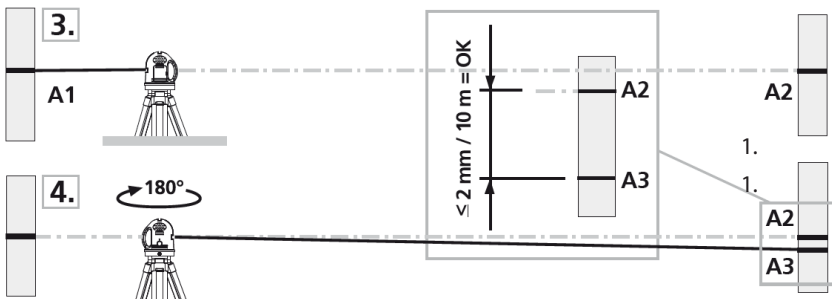

If the distance between A2 and A3 is more than 2mm/10m, the device is in need of calibration. Contact authorised dealer or service agent.

### CHECKING THE VERTICAL LINE

1. Position the device about 5 m from a wall. Fix a plumb bob with a line of 2.5 m length on the wall, making sure that the bob can swing freely.
2. Switch on the device and align the vertical laser to the plumb line. The precision is within the specified tolerance if the deviation between the laser line and the plumb line is not greater than  $\pm 2$ mm.

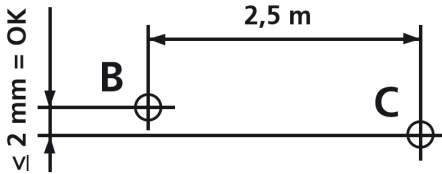

### CHECKING THE HORIZONTAL LINE

1. Position the device about 5m from a wall and switch on the cross laser. Mark point B on the wall.
2. Turn the laser cross approx. 2.5 m to the right and mark point C.
3. Check whether the horizontal line from point C is level with point B to within  $\pm 2$  mm.



# MAINTENANCE AND SERVICE

- Do not attempt to open the device. To ensure product SAFETY and RELIABILITY, repairs, maintenance and adjustment should be performed by authorized service centres. Contact your dealer for more details.
- Do not drop, knock or shake the laser level as this will affect precision.
- Remove batteries when the device is not in use.
- Keep the laser level clean at all times. Use a soft lint-free cloth for the body and lens tissue for glass windows. Do not use abrasive cleaners or solvents.
- Don't expose the laser level to high temperatures or humidity.
- Do not store the laser level in hot areas, hot temperatures can short the life of electronic device, damage battery, and warp or melt certain plastics
- Do not store the laser level in cold areas. When the unit warms up to its normal operating temperature, moisture can form inside where it may damage circuit board.
- Avoid shock, vibrations and extreme heat.
- Do not immerse the instrument in water.
- Always slide the power switch to the OFF position when storing, transporting or moving around the job site.
- Calibration service is recommended at least once a year or as needed.

# TROUBLESHOOTING

| ISSUE                     | POSSIBLE CAUSE AND SOLUTIONS   |
|---------------------------|--|
| Laser does not turn on    | Check batteries. Make sure batteries are installed according to the correct polarity.  |
|                           | The batteries may be depleted. Make sure the batteries are in proper working condition. If in doubt, try installing new batteries. |
|                           | If the laser has been stored in extremely hot temperatures, allow it to cool.  |
| Laser does not level      | Instrument may be outside it's levelling range. Position the instrument, tripod or the base surface.                               |
|                           | Instrument may have impact damage. Contact service centre for repair and calibration.  |
| Laser beam keeps flashing | Instrument may be outside it's levelling range. Position the instrument, tripod or the base surface.                               |

# PRODUCT LABELS

## DT1H1V2PR



## DT1H1V2PG







## WARRANTY INFORMATION

This warranty is provided by DATUM of 20 Thackray Road, Port Melbourne VIC 3207.  
Phone: 1800 868 258.

### **Express Warranty**

Subject to the exclusions set out below, we warrant that this product will be free from defects in materials or workmanship for 3 years (90 days for accessories, batteries and chargers) from the date of purchase.

The benefits conferred by this warranty are in addition to all rights and remedies which you may be entitled to under the Australian Consumer Law, and any other statutory rights you may have under other applicable laws. This warranty does not exclude, restrict or modify any such rights or remedies.

### **Warranty exclusions**

This express warranty does not apply where a defect or other issue with the product is caused by normal wear and tear, misuse or abuse of the product.

### **Consumer guarantees**

Our goods come with guarantees that cannot be excluded under the Australian Consumer Law. You are entitled to a replacement or refund for a major failure and for compensation for any other reasonably foreseeable loss or damage.

You are also entitled to have the goods repaired or replaced if the goods fail to be of acceptable quality and the failure does not amount to a major failure.

### **Warranty claims**

To make a claim under this warranty, you must bring the product along with the proof of purchase and any other documentary evidence which you think is relevant to the your place of purchase where the claim will be handled on our behalf during the warranty period specified above. Any cost incurred by you in bringing the product to the place of purchase will be borne by you.

### **Calibration and repair service**

Datum recommends to check instrument calibration at least once a year or on as needed basis. For calibration or repair service (not covered under warranty), please visit your place of purchase.

